



Die Kompetenzmarke für Energiesparsysteme

D **Montageanleitung**
Ausdehnungsgefäß CS

Seite 2

FR **Instructions de montage**
Vase d'expansion CS

pages 3

BE **Montageaanwijzingen**
Aansluitset COB met CS

NL Pagina 4

ES **Instrucciones de montaje**
Vaso de expansión CS

Página 5

DK **Monteringsvejledning**
Trykekspressionsbeholder CS

Side 6

Lieferumfang:

Ausdehnungsgefäß CS
bestehend aus:

Pos.	Stück	Benennung
1	1	Ausdehnungsgefäß Trinkwasser 8 Liter 10 bar
2	1	Verrohrung KW-Anschluß auf AD Gefäß CS
3	2	Fit.Doppelnippel G3/4" x R3/4" AG
4	2	Flachdichtung 24x17x2
5	1	T - Stück
6	1	Montageanleitung

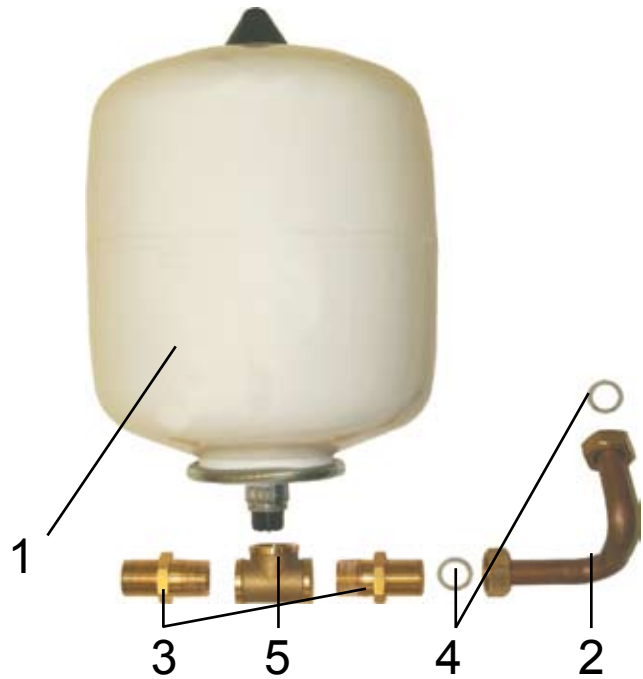

Rückansicht CS

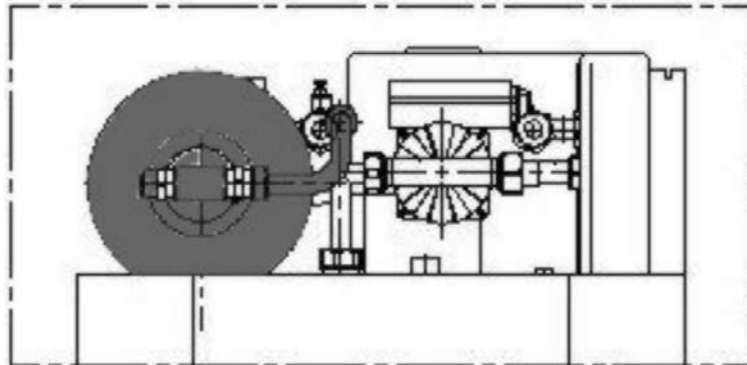

Draufsicht CS

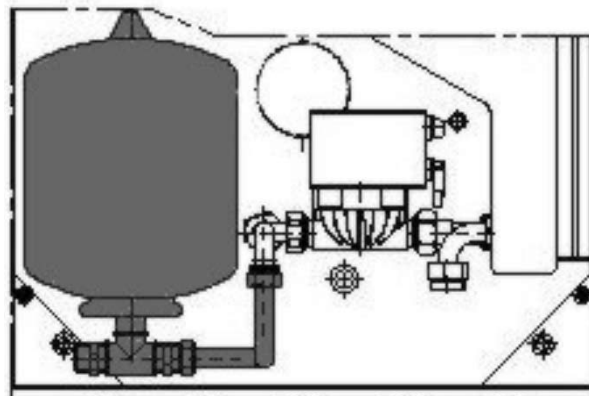

Pièces fournies:**Vase d'expansion CS**

composé de:

Pos.	Quantité	Désignation
1	1	Vase d'expansion pour eau potable, 8 litres, 10 bars
2	1	Tuyauterie avec raccordement eau chaude / eau froide sur vase d'expansion CS
3	2	Embout double du raccord G3/4" x R3/4" filet ext.
4	2	Joint plat 24 x 17 x 2
5	1	Raccord en T
6	1	Instructions de montage

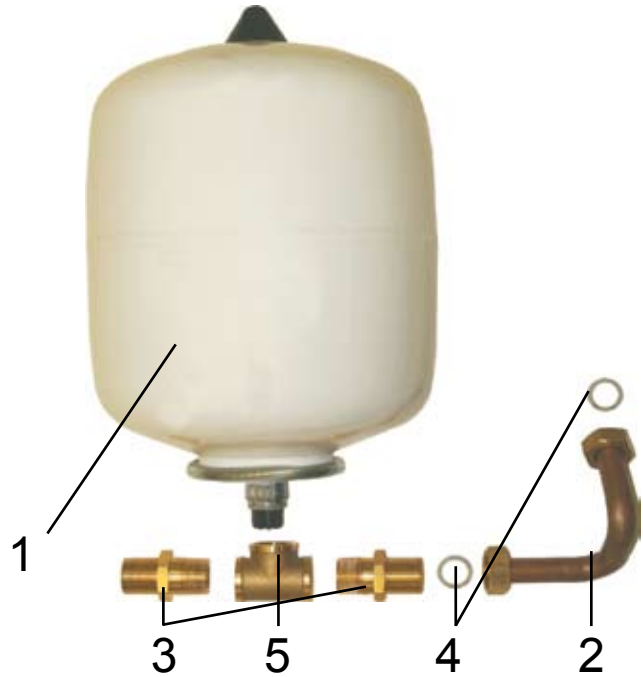
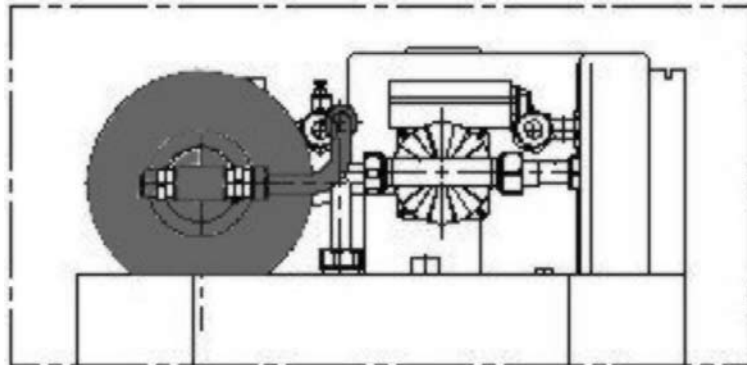
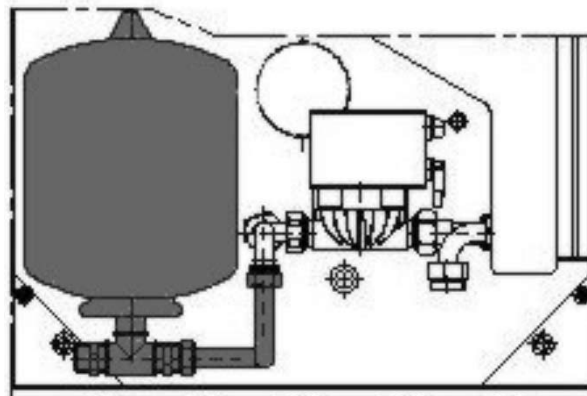
**Vue arrière CS****Vue de dessus CS**

Leveringsomvang:

expansievat CS

bestaat uit:

Pos.	Aantal	Benaming
1	1	Expansievat drinkwater 8 liter 10 bar
2	1	Buisleiding KW-aansluiting op exp vat CS
3	2	Fit.dubbele nippel G3/4" x R3/4" uitwendige schroefdraad
4	2	Vlakke dichting 24x17x2
5	1	T-stuk
6	1	Montageaanwijzingen

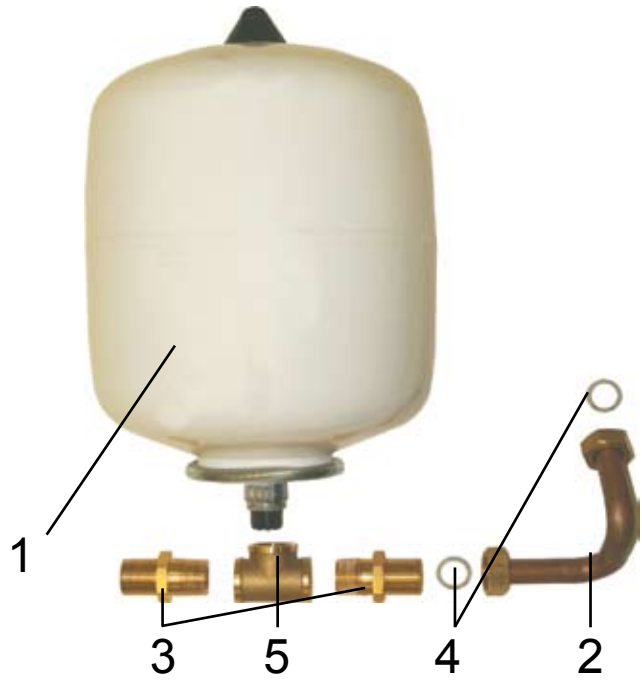

Achteraanzicht CS

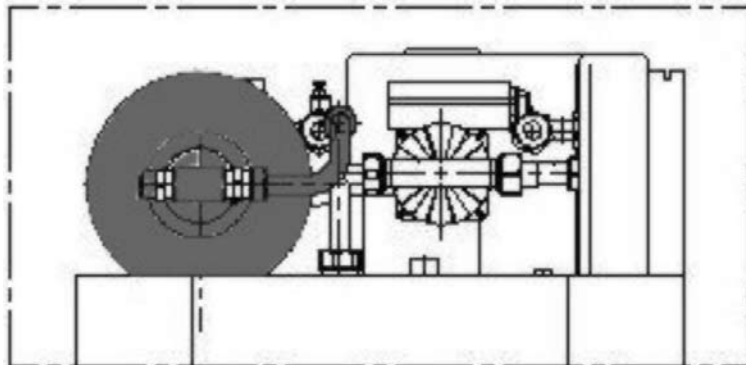

Vooraanzicht CS

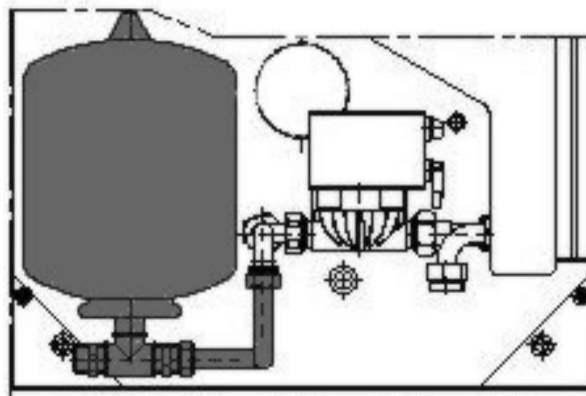

Volumen de suministro:

Vaso de expansión CS

compuesto de:

Pos.	Cantidad	Denominación
1	1	Vaso de expansión agua potable 8 litros 10 bar
2	1	Tubería conexión agua fría a vaso de expansión CS
3	2	Racor boquilla doble G3/4" x R3/4" RE
4	2	Junta plana 24x17x2
5	1	Pieza T
6	1	Instrucciones de montaje

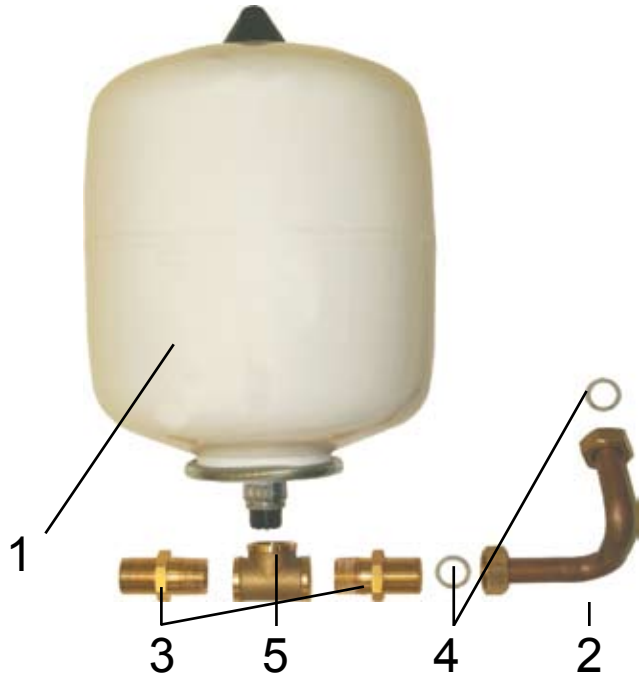

Vista posterior CS

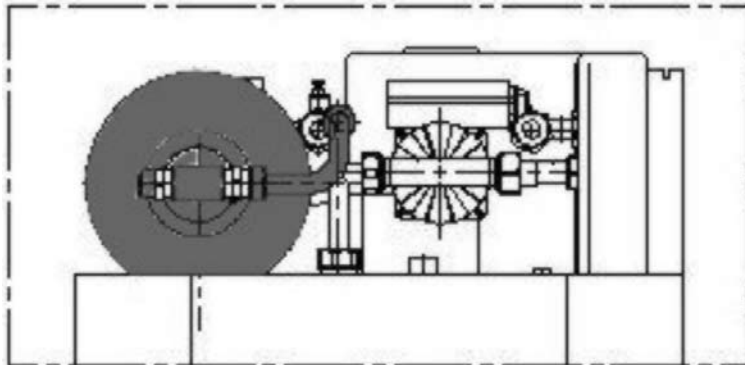

Vista en planta CS

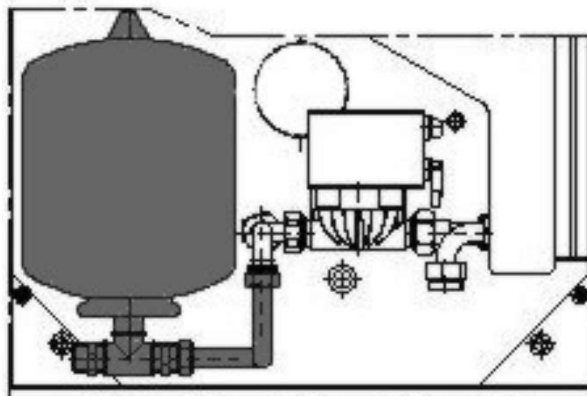

Leveringsomfang:

Trykspansionsbeholder CS

Bestående af:

Pos.	Antal	Beskrivelse
1	1	Trykspansionsbeholder for brugsvand 8 liter, 10 bar
2	1	Rørstykke for KV-tilslutning for ekspansionsbeholder til CS
3	2	Dobbelnippel G3/4" x R3/4"
4	2	Fiberpakning 24 x 17 x 2
5	1	Tee-stykke
6	1	Monteringsvejledning

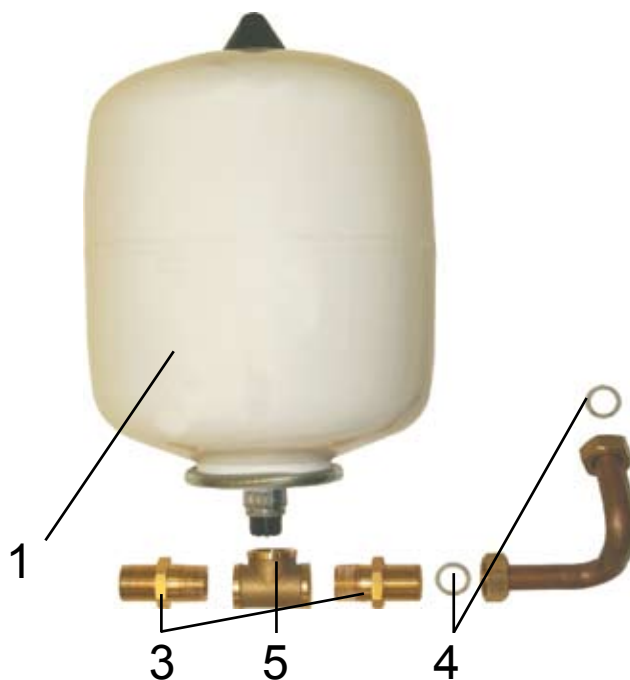

Set bagfra

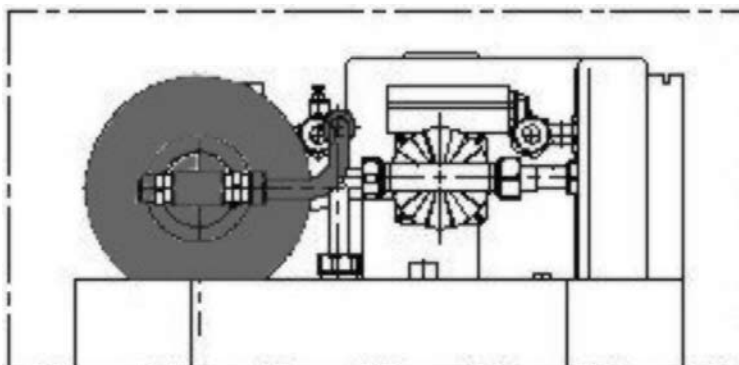

Set ovenfra

